

PYLE[®]
view

**Operating
Instructions**

PLD7HB

7 inch headrest monitor TFT-LCD color monitor
Adjustable headrest monitor

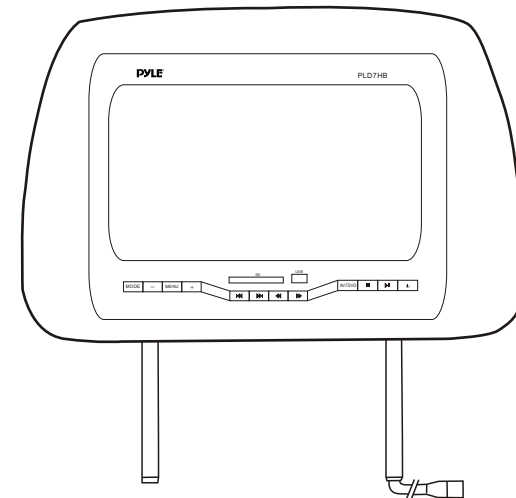
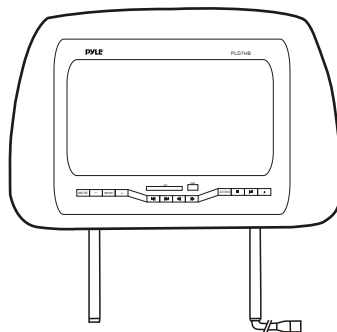

[HTTP://WWW.PYLEAUDIO.COM](http://www.pyleaudio.com)

OPERATING INSTRUCTIONS

Thank you for purchasing headrest monitor. Please read this manual carefully before operating and reserve it for future reference. It will be helpful to you if you encounter any operational problem.

USE INSTRUCTION

1. Please connect the power line and the video line for the unit and power box.. Putting through the nine core cables of the unit to the nine core connector on the power box. Connect the audio and video with AV IN on the box. Connect the DVD output signal with DVD OUT1/DVD OUT2 for output signal. Connect the power line, Red for ACC, Yellow for +12v AND Black for GND.
2. Connect the power wire, turn on the power, it will display the "DVD" picture.
3. It will be auto identify for the PAL system and NTSC system. If the connection is correct it will be show the picture with clearly and colorful.
4. To adjust the brightness, contrast, color, tint for the best result that you need.
5. This set is with USB transfer line, it will be convenience for connect with USB driver.

1. MAINLY SPECIFICATION

Name: Headrest DVD monitor
Pixel format:1440X234 Resolution
System:PAL/NTSC
Power: DC+12V / ±10%
Consumption: 7W
Function: AV+DVD+SD+USB
Picture: 7 inch (16:9)
With function remote control 6M

2. PART NAMES AND FUNCTIONS

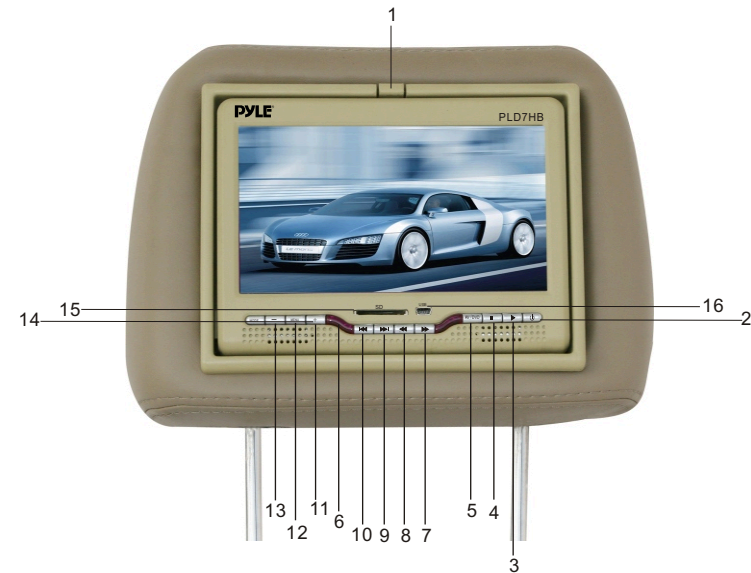

1. Press to open the monitor,
2. ⏻ Power: ON/OFF
3. ▶ Play: DVD Stop, Press will resume playback
4. ■ Stop: ON Play, Press to stop play.
5. AV/DVD : AV/DVD selection button
6. IR receiver window
7. ▶▶ Forward
8. ◀◀ REV
9. ▶▶ Next button
10. ◀◀ Previous button
11. + : Volume + or sub manual up
12. Manu: press to manual
13. - : Volume- or sub manual down
14. Mode : Selection for 16:9 or 4:3
15. SD : SD carder reader
16. SUB : Mini USB connector

3. REMOTE CONTROL UNIT

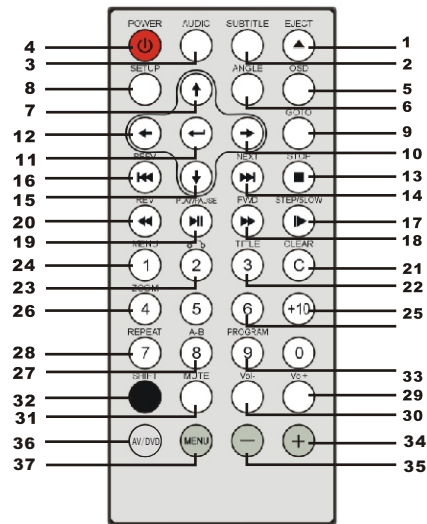

- 1 EJECT**
Eject the disc
- 2 SUBTITLE**
Selecting sub-title
- 3 AUDIO**
DVD: selecting audio language
VCD or CD: Selecting the audio channel
- 4 POWER**
Power on/off the unit
- 5 OSD**
Press this buttons to display the disc and playing information in the LCD
- 6 ANGLE**
Press this to select the DVD angle
- 7 ↑**
Moving cursor Up
- 8 SETUP**
Set up menu when the unit in play mode
- 9 GOTO**
Selecting the Title/Chapter/Time to play
- 10 →**
Moving cursor Right
- 11 ←**
this to confirm settings
- 12 ←**
Moving cursor let

- 13 STOP**
Stop playing disc
- 14 NEXT**
Skip next track/chapter
- 15 ↓**
Moving cursor down
- 16 PREV**
Skip previous track/chapter
- 17 STEP/SLOW**
Press this to enter slowing play when the unit in play mode
Press this to step one frame when the unit in pause mode
- 18 Forward**
Press this to fast forward play when the unit in play mode
- 19 PLAY/PAUSE**
Press this to play or pause
- 20 REV**
Press this to fast backward play when the unit in play mode
- 21 CLEAR**
Clearing the digit that is just input
- 22 TITLE**
Displaying DVD title
- 23 ↶**
Return to menu.
- 24 MENU**
Menu play
- 25 DIGIT INPUT**
- 26 ZOOM**
Zooming the picture
- 27 A-B**
Press this to set A point, press again to set B point, then the unit playing from A to B repeated.
Press 3'rd to cancel the A-B play.
- 28 REPEAT**
DVD: repeat play the title, chapter VCD,CD: repeat the track or whole disc
- 29 VOL+**
Increasing the volume
- 30 VOL-**
Decreasing the volume

31 MUTE

Switch off the speakers or earphone

32 SHIFT

Switching the Digit or Function for the m multi-function key

33 PROGRAM

Programming the play sequence

34 AV/DVD

AV/DVD function selection

35 MENU

+

UP

-

DOWN

Display effect adjust

Precautions before using remote control unit

1. Please pull out the PVC when the remote control unit is first using.
2. Don't drop or step on remote control unit or subject it to shocks.
3. Note that it may not be possible to operate the main unit if there are obstacles between it and the remote sensor.
4. Using the remote control unit within the specified operating range.

Remote control unit operating range

1. Horizontal: ± 30 degree
2. Vertical: ± 30 degree
3. Distance: 5M

Replacing the battery

- 1 Insert your finger nails into A and B on the diagram below, press A according to the direction, then pull out the battery holder.

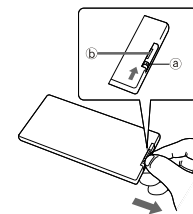

- 2 Remove the old battery, then insert the new battery into the battery holder with the + side facing upwards.

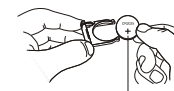

Lithium battery (Cr2025)

- 3 Fit the battery holder back to its place.

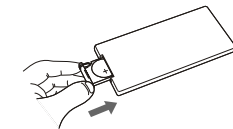

Note:

To prevent leakage of fluid from the lithium battery, remove the battery when not using the remote control unit for long periods of time (one month or more). If the battery leaks fluid, carefully wipe it out of the battery case, then change to a new lithium battery.

4. CONNECTING THE PLAYER TO OTHER COMPONENTS

CONNECTING TO THE POWER BOX

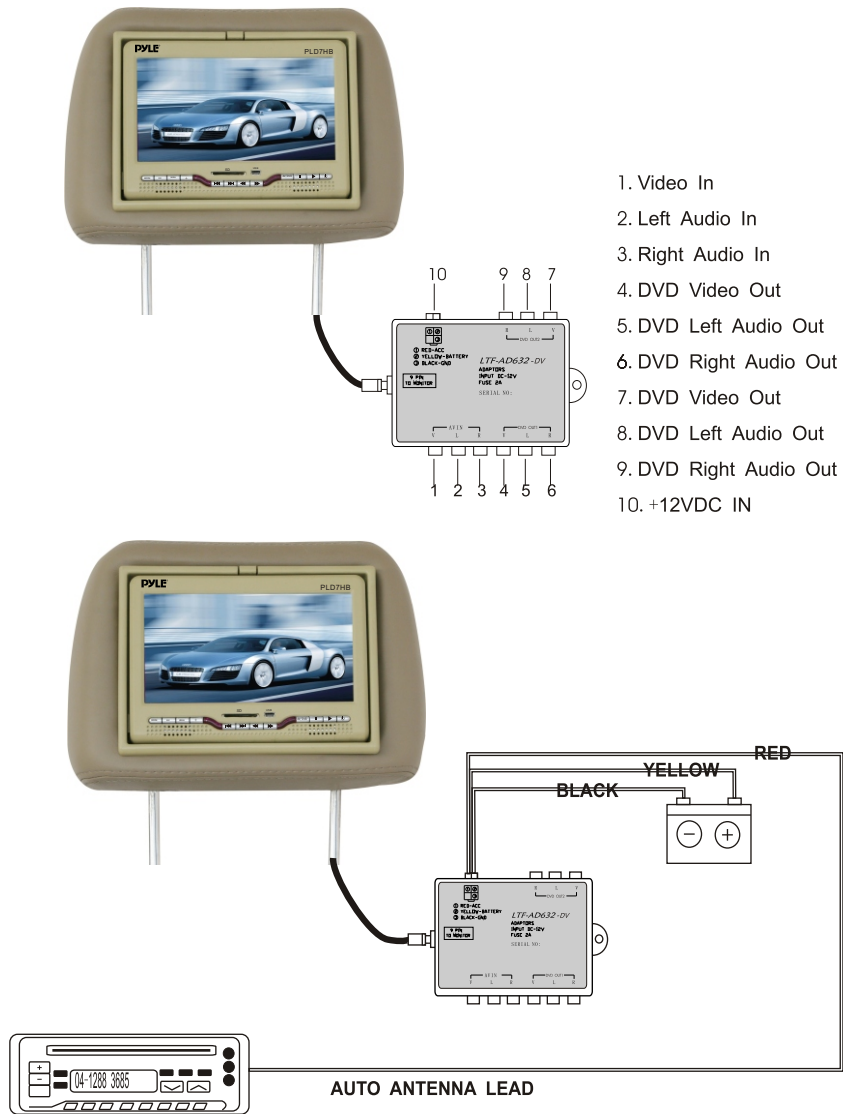

1. Video In
2. Left Audio In
3. Right Audio In
4. DVD Video Out
5. DVD Left Audio Out
6. DVD Right Audio Out
7. DVD Video Out
8. DVD Left Audio Out
9. DVD Right Audio Out
10. +12VDC IN

USB CONNECTING TO THE USB

Use the USB line, (mini USB connector and USB port 1.1), Please reference the following drawing as below:

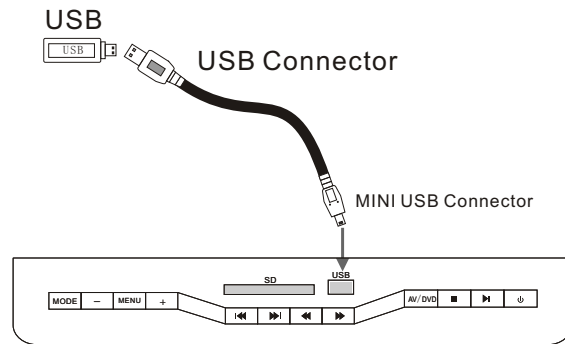

1. Be sure the dish in eject, connector the USB, it will be play the USB
2. It will display "READ USB", then play the file.
3. The menu and the method same as the way of MP3 and JPEG.
4. Pull out the USB when you want to stop playing.

NOTE:

Be sure the DVD is in ejected, then connect the USB, it will be work. Be sure the format of the file in USB is fit with the unit, otherwise must formatting the USB before connect with USB

CONNECTING WITH SD CARD

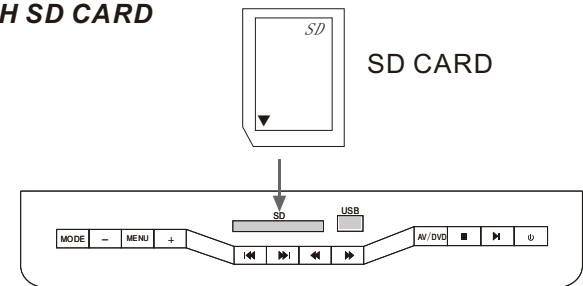

1. Plug the SD card to the SD card slot, it will be read the file of SD card.
2. It will display "READ CARD" on the screen, then will show the file of SD card.
3. The menu and the method same as the way of MP3 and JPEG.
4. Pull out the SD card when you want to stop the playing.

NOTE:

It unit just work with SD card.

Be sure the DVD is in ejected, then the SD card will be work.

Be sure the direction of SD card is in correct when plug in the SD card.

5. BASIC OPERATIONS

A Using OSD

1. Press OSD to show the play and disc information in the LCD when the main unit is in play mode.
2. Press OSD again to disable the information display.

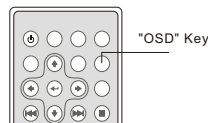

B Selecting an audio

1. Press AUDIO to select the audio language when the main unit is in play mode for DVD disc.
2. Press AUDIO to select the audio channel when the main unit is in play mode for VCD, CD disc.;

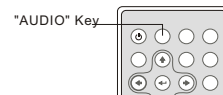

C Selecting a sub-title

Press SUBTITLE to select the sub-title when the main unit is in play mode.

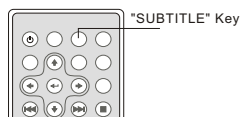

D Selecting an angle

1. Press ANGLE to select the play angle when the main unit is in play mode for DVD disc, there is no function for other disc.
2. It will be no working if the dish not have this function.



E Stopping the playing

1. Press STOP to pause the playing, the unit can memorize the play point.
 2. Press PLAY to continues play from the pausing point
 3. Press STOP to stop the disc.
- NOTE: The unit can not play to continues playing for some disc.

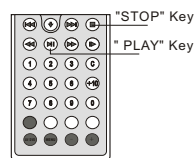

F Pausing the disc

1. Press PLAY/PAUSE to pause the playing when playing.
2. Press PLAY/PAUSE to continues playing.

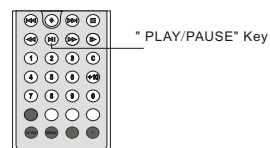

G Scanning forward and backward

1. Press FMD to fast the playing.
2. Change the playing speed to X2 X4 X8 X20, and normal for every pressing to back the normal speed.
3. Press REV to backward playing, change the playing speed to X2 X4 X8 X20, and normal for every pressing to back the normal speed.

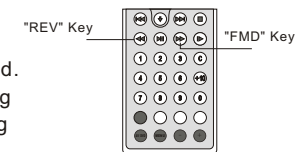

H Slow playing the disc

1. Press STEP/SLOW in the remote control unit to slow playing. Change the playing speed to 1/2, 1/3, 1/4, 1/5, 1/6 and 1/7 for every pressing STEP/SLOW.
 2. Press STEP/SLOW to skip frame when the unit is in pause mode.
- Note: The sound is mute when the main unit is in fast or slow playing except CD and MP3 disc. Press PLAY to resume normal playing.

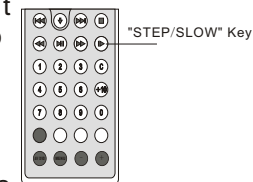

I Repeat playing the disc

1. A-B play mode: Press A-B, the LCD will show Repeat A-. Press A-B again, the main unit will repeat the play from A to B.. Press A-B again, the unit will resume normal playing.
2. Repeat playing the title, chapter or track.: Press REPEAT to select the title, chapter or track when the unit is in play mode. DVD: title, chapter; VCD or CD: track.

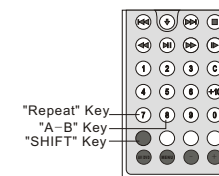

NOTE:

Please press SHIFT to select the FUNCTION mode of remote control unit first

J Searching the disc

Press SEARCH
Using cursor key and ENTER to select the proper playing item. Input digit to select playing time, title, chapter or track.
Press ENTER to confirm the playing item
Press SEARCH to resume the play mode.



K Zoom playing

Press ZOOM every times,
The picture will change to
2X 3X 4X 1/2X 1/3X, 1/4X and normal.

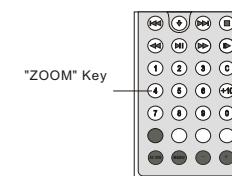

L Program playing

The main unit may play the list according to the following program list:

1. Press PROGRAM, the menu will shown in the LCD

Hint: T is for Title, C is for Chapter for DVD disc.

PROG		
T C	T C	T C
1-- : ---	5-- : ---	9-- : ---
2-- : ---	6-- : ---	10-- : ---
3-- : ---	7-- : ---	11-- : ---
4-- : ---	8-- : ---	12-- : ---
Play	Clear	Exit

NOTE: There is no title, chapter or track for some disc.

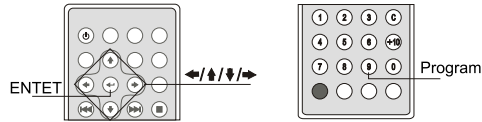

2. Using digit $\leftarrow/\uparrow/\downarrow/\rightarrow$ and cursor to select the list what you want. See the picture.

PROG		
T C	T C	T C
1 01 : 001	5-- : ---	9-- : ---
2 02 : 002	6-- : ---	10-- : ---
3-- : ---	7-- : ---	11-- : ---
4-- : ---	8-- : ---	12-- : ---
Play	Clear	Exit

3 Using $\leftarrow/\uparrow/\downarrow/\rightarrow$ the cursor key to move the cursor to PLAY icon, and press ENTER to start play the list.

4 Using the cursor key to move the cursor to CLEAR icon, and Press ENTER to clear the play list.

5 Press PLAY/PAUSE or select the EXIT icon and press ENTER to exit program menu.

NOTE: The program list will be cancel whe the main unit is power off or eject the disc.

There is no program function for some disc.

The unit can not play the list if you select the item that does not exit in the disc.

M Playing MP3 and JPEG disc

1. Directory
2. File
3. Mp3 icon
4. JPEG icon

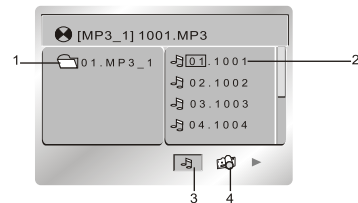

- Using $\leftarrow/\uparrow/\downarrow/\rightarrow$ the cursor key to move the cursor to the directory, fild, MP3 icon or JPEG icon.
- Selecting MP3 icon and press ENTER if you want to play Mp3, selecting JPEG icon and press ENTER if you want to play JPEG.
- Selecting a file and press ENTER if you want to play the file.
- Press A-B to repeat A-B playing.

NOTE: The LCD will be off if there is no operation on the unit over 3 minutes when playing CD, MP3. And the Power LED will be flash in the status. LCD will be on for any operation on the unit.

6. BASIC SETTING

The unit with two inputs: AV and DVD. Turn on the power, press AV/DVD on the unit or remote control to select the input.

AV/DVD mode

When the unit is playing, press the MENU on the unit or remote control to enter the menu setting, select the mode that you want, then press the + or - on remote control to select that you want.

- 1). BRIGHTNESS
- 2). COLOR
- 3). CONTRAST
- 4). TINT
- 5). LANGUAGE
- 6). MODE

Operation

- 1). Press the "MENU" one time on unit or remote control to menu of brightness setting, press "+" or "-" to select what you want.
- 2). Press the "MENU" two times on unit or remote control to menu of color setting, press "+" or "-" to select what you want.
- 3). Press the "MENU" three times on unit or remote control to menu of contrast setting, press "+" or "-" to select what you want.
- 4). Press the "MENU" four times on unit or remote control to menu of Tint setting, press "+" or "-" to select what you want.
- 5). Press the "MENU" five times on unit or remote control to menu of language setting, press "+" or "-" to select what you want.
- 6). Press the "MENU" six times on unit or remote control to menu of mode setting, press "+" or "-" to select what you want.

7. MAIN UNIT SETTINGS

Press SETUP when the main unit is in play mode. The set up menu will be displayed in LCD.

1. SYSTEM SETUP

1) .TV SYSETM

Please select the proper video signal system if you want to see on a TV set.
Default: NTSC

NOTE: The picture may be a grey picture if the system is not correctly set.

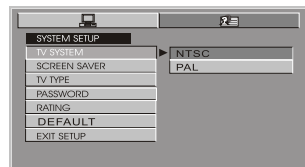

2) .SCREEN SAVER

This function can save in stop, no disc over 1 minutes.

Select OFF to turn on the saver, Select ON to disable saver.

Default is saver.

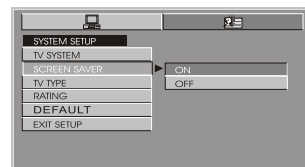

3).TV TYPE

Selecting a TV scale, with 16:9, 4:3 LB and 4:3 PS.

NOTE: Picture scale is depending the disc. Please select the correct scale.

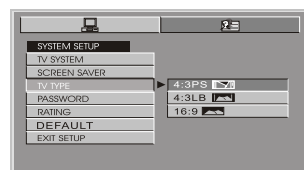

4).PASSWORD

Default setting: 0000. When unlock, new parent lock can be input and select the parent lock level..

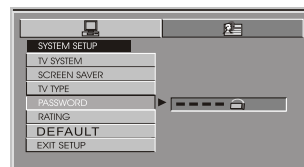

5) .RATING

This setting can control the unit play parent lock DVD disc. Level is divided in to 2 level: normal and children.

Selecting Normal the lock is cancel.

Default: Normal

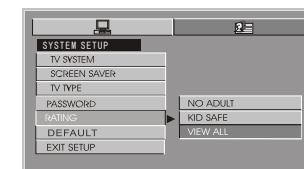

OTE: The parent lock level can not be set if the parent lock is locked.

6).DEFAULT

To restore the factory setting, please select this item and press ENTER.

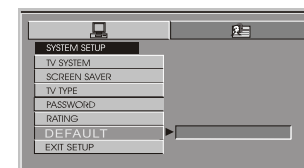

8).EXIT SETUP

Exit the setting.

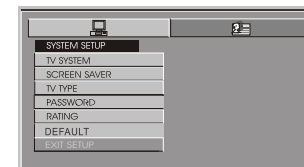

2. LANGUAGE SETUP

1) .OSD LANGUAGE

Selecting a OSD language: Please enter the OSD language select menu, use cursor key to move the cursor to the language what you want and press ENTER.

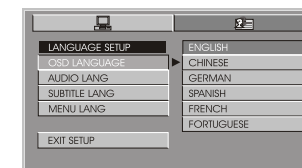

2).AUDIO LANG

Selecting a audio language Please enter the audio language select menu, use cursor key to move the cursor to the language what you want and press ENTER.

If the disc not have the language, it is not showing this language.

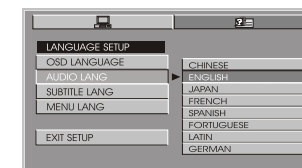

3).SUBTITLE LANG

Selecting a sub-title language:
Please enter the sub-title language select menu, use cursor key to move the cursor to the language what you want and press ENTER

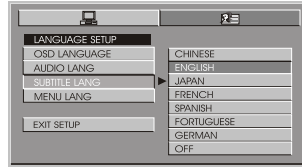

4). MENU LANG

Selecting a menu language:
Please enter the menu language select menu, use cursor key to move the cursor to the language what you want and press ENTER.



5).EXIT SETUP

Exit the language setting

NOTE: The language will be the disc default language if the language you want is not visible.

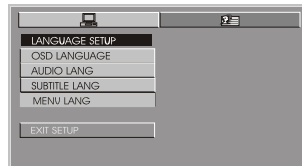





Default language: English

8. CAUTIONS ON USING THIS PLAYER

1. Be sure the anode and cathode is correct connection.
2. To reduce the risk of fire or electric shock, do not expose this appliance to rain or moisture.
3. Do not open the cabinet, refer servicing to qualified personnel only.
4. Installation should be very fasten. Preventing the fallen unit hurt people when moving on or a sudden brake.
5. DC 12V should best be connected to the power adapter to prevent from the over-voltage drop the may influence the normal work of monitor.
6. A few high lights or dark spots may occur on the LCD screen. It is a very common phenomenon to the active matrix display technology, and never necessary means any defects or faults.
7. Do not using the disc that is scratched seriously, otherwise will damage the DVD.

9. The discs listed on the below can be played on this player without any adapter.

The discs listed on the below can be played on this player without any adapter

	DVDs	12cm
	Vedio CDs	12cm
	Audio CDs	12cm
	MP3 CDs	12cm
	JPG CDs	12cm

Specifications

Disc type	DVD Vedio VedioCD	CD-DA MP3 JPEG
Video output	Vedio output Video output: 1.0Vpp/75ohm	
LCD panel	7" color TFT Pixels: 1440×234	
Power	AC-DC adapter 12V/1.5A Battery 7.4V/3100mAh	

Trouble shooting

Please refer the following instruction when there are some problem with this unit. If the problem still exit, please consult your nearest service center.

PROBLEM	POSSIBLE REASON	SOLUTION
Disc can not play	Disc error	Insert disc in right direction
	Disc dirty or scratch	Using good disc
	Area code error	Using right area code disc
No picture in TV	Cable loosen	Insert the cable again
	Setting error	Set TV or this unit correctly
Speaker no sound	Earphone in use	Removing earphone
	Cable loosen	Insert the cable again
No sound in TV or amplifier	Connecting cable error	Connecting cable correctly
	Different volume for DVD/CD disc	Adjust volume level
Can not play 8cm disc	8cm disc is not play in this unit	removing disc from the unit.